

FEED-THROUGH 35 or 32mm DIN Rail

Altech "U" Series Universal Rail Mounting Standard Screw Clamp Feed through terminals are the most versatile terminals for wire-to-wire connection in control, automation, instrumentation and power distribution applications. A special design feature on the flexible foot enables easy mounting and dismounting from the DIN Rail with the help of a screwdriver.

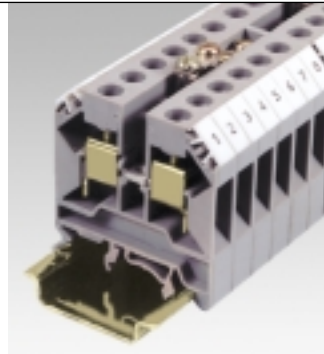

The terminals with AEx eII EEx eII are explosion proof. They can be used in potentially explosive atmosphere which may occur in chemical and petrochemical industry. These terminals can be used in Class 1, Zone 1 hazardous locations. These terminal blocks comply to En 500019.





Terminal Width	5 mm
Height x Length	45 x 43 mm
Stripping Length	9 mm
Insulation Material	Polyamide 6.6
Type of Connection	2 screw clamps & 1 tapped hole for cross connection
Approvals	  
Wire Range	22-14 AWG 0.5-2.5 sq.mm 22-14 AWG
Voltage Rating	600 V 750 V 600 V
Current Rating	20 A 24 A 20 A
Torque	7 lb-in 0.4 Nm 7 lb-in

CTS2.5U-N		
 		
Terminal Width	5 mm	
Height x Length	45 x 43 mm	
Stripping Length	9 mm	
Insulation Material	Polyamide 6.6	
Type of Connection	2 screw clamps & 1 tapped hole for cross connection	
Approvals	  	
Wire Range	22-14 AWG 0.5-2.5 sq.mm 22-14 AWG	
Voltage Rating	600 V 750 V 600 V	
Current Rating	20 A 24 A 20 A	
Torque	7 lb-in 0.4 Nm 7 lb-in	

CTS4U-N		
 		
Terminal Width	6 mm	
Height x Length	45 x 43 mm	
Stripping Length	9 mm	
Insulation Material	Polyamide 6.6	
Type of Connection	2 screw clamps & 1 tapped hole for cross connection	
Approvals	  	
Wire Range	22-12 AWG 0.5-4 sq.mm 22-10 AWG	
Voltage Rating	600 V 750 V 600 V	
Current Rating	25 A 32 A 35/40A*	
Torque	7 lb-in 0.5 Nm 7 lb-in	

Terminal Block	Cat. No.	Std. Pk.	Cat. No.	Std. Pk.
End Plate 	EP2.5/4UN	50	EP2.5/4UN	50
Isolation Partition 	PP2.5/4UN	50	PP2.5/4UN	50
Separator Plate 	SP2.5/4UN	100	SP2.5/4UN	100

DIN Rail	for ordering information refer to page 57
	

End Stop	for ordering information refer to page 58	CA702	50	CA702	50
		CA802	50	CA802	50

Internal Jumper	2 pole	CA721/2	100	CA722/2	100
	3 pole	CA721/3	50	CA722/3	50
	4 pole	CA721/4	50	CA722/4	50
	10 pole	CA721/10	10	CA722/10	10
	100 pole	CA721/100	5	CA722/100	5

Insulated Internal Jumper	2 pole	CA741/2	100	CA742/2	100
	3 pole	CA741/3	50	CA742/3	50
	4 pole	CA741/4	50	CA742/4	50
	10 pole	CA741/10	10	CA742/10	10
	100 pole	CA741/100	5	CA742/100	5

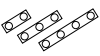
Current Bars	2 pole	CA703/01	100	CA703/1	100
	3 pole	CA704/01	100	CA704/1	100
	4 pole	CA705/01	100	CA705/1	100
	10 pole	CA731/10	100	CA732/10	100
	10 pole (breakable)	—	—	CA732/10-A	100
	100 pole	CA731/100	10	CA732/100	10

Shorting Sleeve & Screw	CA 707/S/Q/01	100	CA707/S/Q/01	100
				

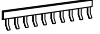
External Jumper	2 pole	CA717/2	100	CA713/2	100
	3 pole	CA717/3	100	CA713/3	100
	4 pole	CA717/4	100	CA713/4	100
	10 pole	CA717/10	50	CA713/10	50



Marking Tags (MT Type)	MT5	100	MT6	100
				

Continuous 90mm strip	MT9F	10	MT9F	10
				

COLOR BLOCKS











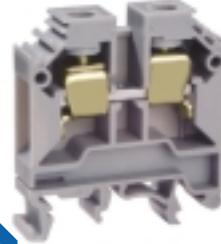
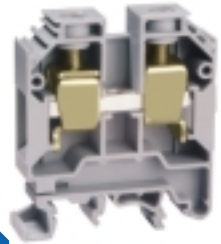

When ordering please add color suffix to Cat. No.

Example: CTS2.5U-N/R

Color	Ordering Suffix
Red	R 
Blue	BU 
Black	BL 
Orange	O 
Green	G 
Yellow	Y 
White	W 
Beige	BG 

Was 10A please make 40A.

* 35A with one No. 10 AWG and 40A with two No. 12 AWG wires.

CTS6U			CTS10U			CTS25U			CTS35U		
											
 AEx eII EEx eII 			 AEx eII EEx eII 			 AEx eII EEx eII 			 AEx eII EEx eII 		
8 mm			10 mm			12 mm			15 mm		
47 x 43 mm			47 x 43 mm			56 x 49.5 mm			58 x 52.5 mm		
12 mm			12 mm			18 mm			18 mm		
Polyamide 6.6			Polyamide 6.6			Polyamide 6.6			Polyamide 6.6		
2 screw clamps & 1 tapped hole for cross connection			2 screw clamps & 1 tapped hole for cross connection			2 screw clamps & 1 tapped hole for cross connection			2 screw clamps & 1 tapped hole for cross connection		
  			  			  			  		
22-8 AWG 1.5-6 sq.mm 22-8 AWG			15-7 AWG 1.5-10 sq.mm 20-6 AWG			9-3 AWG 6-25 sq.mm 14-2 AWG			7-2 AWG 10-35 sq.mm 18-1/0 AWG		
600 V 750 V 600 V			600 V 750 V 600 V			600 V 750 V 600 V			600 V 750 V 600 V		
50 A 41 A 50 A			65 A 57 A 65 A			115 A 101 A 115 A			145 A 125 A 145 A		
9 lb-in 0.8 Nm 14 lb-in			14 lb-in 1.2 Nm 14 lb-in			14 lb-in 2.0 Nm 14 lb-in			25 lb-in 2.5 Nm 25 lb-in		
Cat. No.	Std. Pk.		Cat. No.	Std. Pk.		Cat. No.	Std. Pk.		Cat. No.	Std. Pk.	
CTS6U	100		CTS10U	100		CTS25U	50		CTS35U	50	
EP6/10U	50		EP6/10U	50		EP25U	50		EP35U	50	
PP6/10U	50		PP6/10U	50		PP25U	50		PP35U	50	
											
CA702	50		CA702	50		CA702	50		CA702	50	
CA802	50		CA802	50		CA802	50		CA802	50	
CA723/2	100		CA724/2	100		CA725/2	50		CA726/2	50	
CA723/3	50		CA724/3	50		CA725/3	25		CA726/3	25	
CA723/4	50		CA724/4	50		CA725/4	25		CA726/4	25	
CA723/10	10		CA724/10	10		CA725/10	10		CA726/10	10	
CA743/2	100		CA744/2	100		CA745/2	50		CA746/2	50	
CA743/3	50		CA744/3	50		CA745/3	25		CA746/3	25	
CA743/4	50		CA744/4	50		CA745/4	25		CA746/4	25	
CA743/10	10		CA744/10	10		CA745/10	10		CA746/10	10	
CA703/2	100		CA703/3	100		CA703/4	100		CA703/5	100	
CA704/2	100		CA704/3	100		CA704/4	100		CA704/5	100	
CA705/2	100		CA705/3	100		CA705/4	100		CA705/5	100	
CA733/10	100		CA734/10	100		CA735/10	100		CA736/10	100	
CA707/S/Q/1	100		CA707/S/Q/1	100		CA707/S/Q/2	100		CA707/S/Q/2	100	
CA710/2	100		CA718/2	100							
CA710/3	100		CA718/3	100							
CA710/4	100		CA718/4	100							
CA710/10	50		CA718/10	50							
MT8	100		MT10	100		MT12	100		MT15	100	
MT9F	10		MT9F	10		MT9F	10		MT9F	10	

HIGH CURRENT TERMINAL BLOCKS

Altech offers Universal Mounting Feed Through terminal blocks for wires with a large cross section and high current application. Versatile Screw Clamp system used in the terminal providing gas tight connection, ensures reliable electrical connection with very low contact resistance.

The specially designed slot in the feet can be used for mounting and dismounting from the mounting rail with the help of a screw driver.





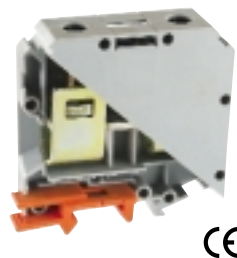

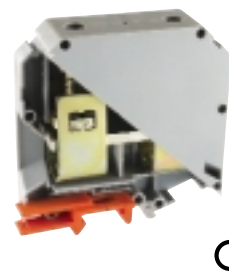

CTS50U



CTS95U



Terminal Width	20.5 mm		25 mm	
Height x Length	75.5 x 71 mm		90 x 83 mm	
Stripping Length	22 mm		24 mm	
Insulation Material	Polyamide 6.6		Polyamide 6.6	
Type of Connection	2 screw clamp connections		2 Allen screw clamp connections	
Approvals				
Wire Range	16-50 sq.mm	6-2/0 AWG	16-95 sq.mm	2-4/0 AWG
Voltage Rating	1000 V	600 V	1000 V	600 V
Current Rating	150 A	150 A	232 A	230 A
Torque	6.8 Nm	60 lb-in	18.2 Nm	160 lb-in

Terminal Block	Cat. No.	Std. Pk.	Cat. No.	Std. Pk.
	CTS50U	20	CTS95U	10
DIN Rail <i>for ordering information refer to page 57</i>	 		 	
End Stop <i>for ordering information refer to page 58</i>	CA802	50	CA802	50
	CA702	50	CA702	50
Marking Tags (MT Type) 	MT20	100	MT25	100

38032

38020

38019

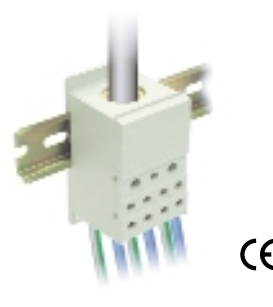
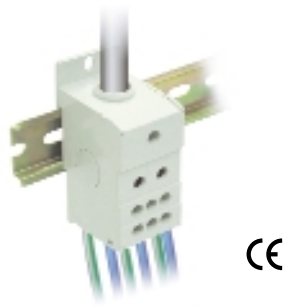

Part Number:

38032

38020

38019

Approvals



Current Rating

160A

160A

230A

250A

310A

400A

Voltage Rating

600V AC

690V AC

600V AC

690V AC

600V AC

690V AC

No. of Inputs

1

1

1

1

1

1

Wire Range

8-2/0AWG

10-70mm²

2-4/0AWG

35-120mm²

3/0-350kcmil

95-185mm²

Torque

35.5lb. in.

4Nm

170lb. in.

19Nm

230lb. in.

25Nm

No. of Outputs

6

6

11

11

11

11

Wire Range

14-6 AWG

2.5-16mm²

2x 14-2AWG

2.5-35mm²

2x 14-2AWG

2.5-35mm²

Torque

17.5lb. in.

2Nm

31lb. in.

3.5Nm

31lb. in.

3.5Nm

Wire Range

5x 14-6AWG

2.5-16mm²

5x 14-6AWG

2.5-16mm²

Torque

17.5lb. in.

2Nm

17.5lb. in.

2Nm

Wire Range

4x 14-8AWG

2.5-10mm²

4 x 14-8AWG

2.5-10mm²

Torque

17.5lb. in.

2Nm

17.5lb. in.

2Nm

Dimensions:

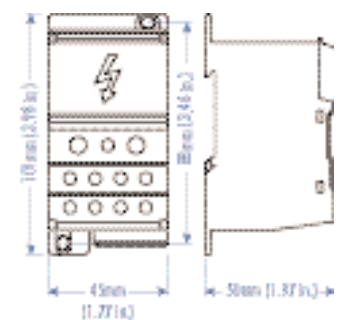
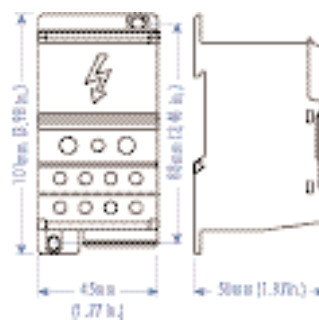
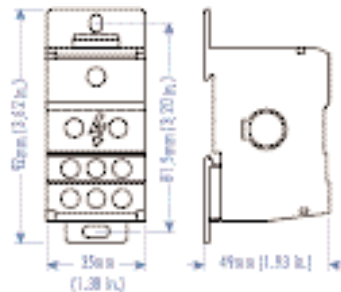

Accessories
Part Number:

Copper Jumper Bar
3803221 for 2 Blocks
3803231 for 3 Blocks
3803241 for 4 Blocks
can be cut to customer needs



THREE PHASE POWER DISTRIBUTION BLOCKS

- Speed of mounting and wiring
- IP20 Finger Safe
- DIN Rail or Panel Mount
- Blocks fit with other DIN Rail mountable modular devices
- Same compact size for both ratings

38075

38073



3 Pole



Part Number:

38075

38073

Approvals



	38075		38073	
Current Rating	115A	115A	175A	175A
Voltage Rating	600V AC	690V AC	600V AC	690V AC
No. of Inputs	3x1	3x1	3x1	3x1
Wire Range	8-2AWG	10-35mm ²	8-2/0AWG	10-70mm ²
Torque	31lb. in.	3.5Nm	35.5lb. in.	4Nm
No. of Outputs	3x6	3x6	3x6	3x6
Wire Range	14-4AWG	2.5-16mm ²	14-4AWG	2.5-16mm ²
Torque	17.5lb. in.	2Nm	17.5 lb. in.	2Nm

Dimensions:

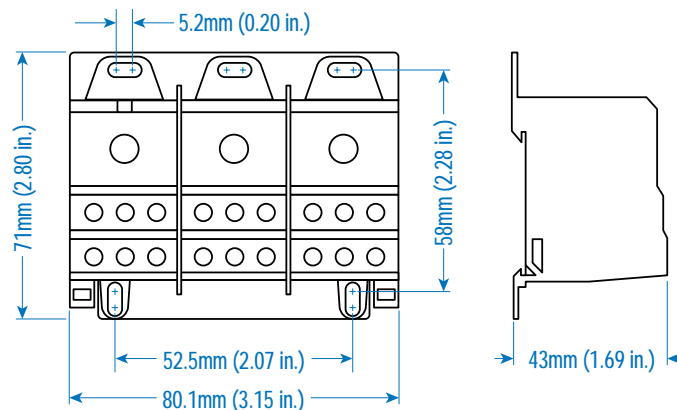

GROUND 35 and 32mm DIN Rail

Use ground blocks instead of grounding studs and wire lugs to terminate ground wires, saving installation and wiring time.

Ground blocks clamp mechanically onto the DIN Rail by tightening the center mounting screw, making a reliable electrical connection between the cage clamp terminals and the DIN Rail. The rail serves as a busbar and automatically distributes ground potential to all other ground terminals on the same rail.

Ground blocks can also be used as end stops, preventing other terminal blocks and components from moving laterally on the DIN Rail.

They are supplied with a standard green/yellow housing for easy identification and accept standard marking tags.

CGT4U, CGT10U and CGT35U can be mounted on both DIN 32mm and DIN 35mm rails.

CGT4N can be mounted on 35mm DIN rail and has the same top outer profile as the feed through blocks (CTS4U-N, CTS2.5U-N).

CGMT4 can be mounted on 15mm DIN rails and has the same top outer profile as the CMT4 feed through blocks.

- High density
- Screw-cage clamp
- Special clamping foot
- Polyamide 6.6
- Color: green/yellow

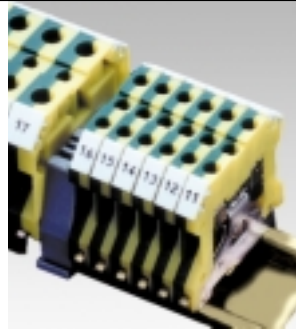

Terminal Width
Height x Length
Stripping Length
Insulation Material
Type of Connection
Approvals
Wire Range
Torque

Terminal Block
DIN Rail <i>for ordering information refer to page 57</i>
Marking Tags (MT Type)
Continuous 90mm strip

CGT4U



CE
TUV AEx eII EEx eII

CGT4N



CE

6 mm
48 x 43 mm
9 mm
Polyamide 6.6
2 screw clamps
SP US, VDE, RU US
22-12 AWG 0.5-4 sq.mm 22-10 AWG
7 lb-in 0.5 Nm 7 lb-in

6 mm
45.4 x 54.2 mm
9 mm
Polyamide 6.6
2 screw clamps
IEC, RU US
0.5-4 sq.mm 22-10 AWG
0.8 Nm 7 lb-in

Cat. No.	Std. Pk.
CGT4U	50
MT6	100
MT9F	10

Cat. No.	Std. Pk.
CGT4N	50
MT6	100
MT9F	10

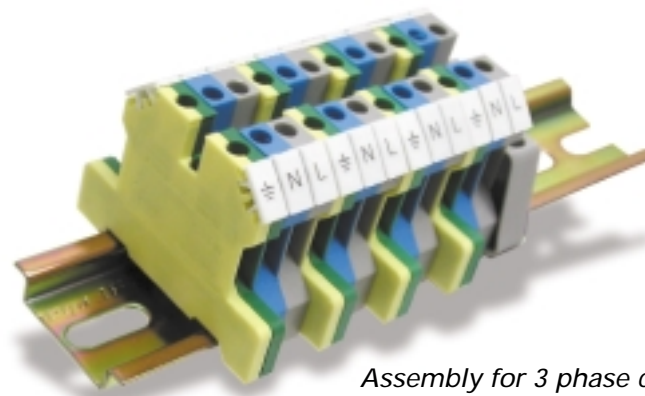

Assembly for 3 phase circuits.

CKT4U



CE

6 mm

46 x 46.3 mm

9 mm

Polyamide 6.6

2 screw clamps



22-12 AWG 0.5-4 sq.mm 22-10 AWG

600 V 750 V 600 V

16 A 16 A 16 A

7 lb-in 0.5 Nm 7 lb-in

CSDL4U



CE

8 mm

43 x 58 mm

9.5 mm

Polyamide 6.6

2 screw clamps



22-12 AWG 0.5-4 sq.mm 22-10 AWG

600 V 750 V 600 V

6.3 A 6.3 A 6.3 A

7 lb-in 0.5 Nm 7 lb-in

DDDL4U



CE

8 mm

66 x 88 mm

9.5 mm

Polyamide 6.6

4 screw clamps



0.5-4 sq.mm 22-10 AWG

600 V 600 V

6.3 / 32 A 6.3 / 25 A

0.5 Nm 7 lb-in

Cat. No. Std. Pk.

CKT4U 50

EPCKT4U 50

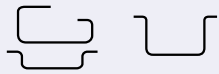

CA702 50
CA802 50

CA713/2 100
CA713/3 100
CA713/4 100
CA713/10 50

MT6 100

MT9F 10

Cat. No. Std. Pk.

CSDL4U 100

EPCSFL4U 50

PPCSFL4U 50

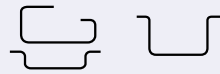

CA702 50
CA802 50

CA711/2 100
CA711/3 100
CA711/4 100
CA711/10 50

MT8 100
MT2 100

MT9F 10

Cat. No. Std. Pk.

DDDL4U 20

EPDDL4U 25

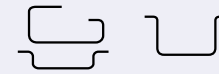

CA702 50
CA802 50

CA711/2 100
CA711/3 100
CA711/4 100
CA711/10 50

MT8 100
MT2 100

MT9F 10

¹ Consult Altech.

FUSE BLOCKS

Certain electrical and control systems require protection by fuses. The terminal has a moving type hinged carrier. CSFL4 which has a specially designed space for cartridge type glass fuse accepts Ø5 x 20 or Ø5 x 25 mm fuses. CAFL4U accepts Ø1/4 x 1-1/4 in. fuses. The fuse can be engaged or disengaged by the movement of the carrier.

Altech fuse terminals are also available with light indication - CSFL4U(L). A specially designed built-in circuit gives light indication in the event of fuse blow out. Thus, fault in a circuit can be easily located.

However, an application of such terminals must take into consideration residual current flow.

DDFL 4U - Double Level Fuse Terminal with fuse link on the top level has a separate feed through terminal at the lower level. This eliminates use of an additional feed through terminal.

In DDFL 4U (E), specially designed built in circuit gives light indication in the event of a fuse blow out at the top level. The terminal provides separate feed through connection possibility at the lower level.

DDFL 4U (LR): This is a modified version of DDFL 4U (E) terminal where in two equipotential connection points are available on both ends of the terminal.





CAFL4U(L) is equipped with a LED for blown fuse indication. CAFL4U(N) is equipped with a neon bulb for same application.



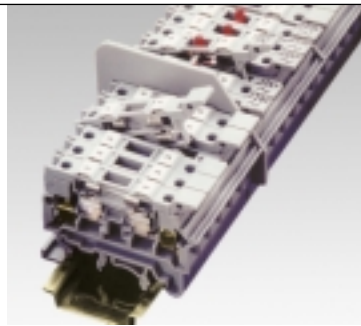

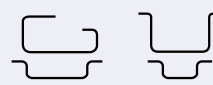

CB1038 accepts Ø10 x 38mm fuse.

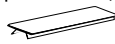
Fuses are sold separately by Altech, see page 31 for details.

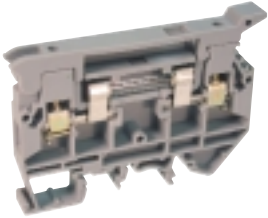
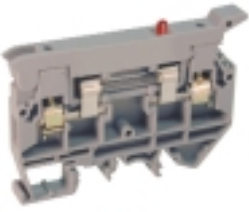
*Add required voltage to part number as a suffix. i.e. CSFL4U(L)/24 for 24V AC/DC.

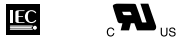



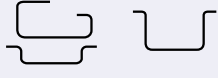
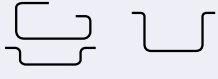
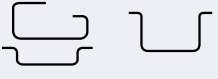
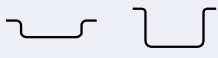





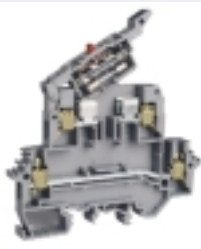





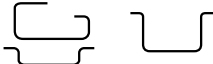

	CSFL4U			CSFL4U(L)*		
Terminal Width	8 mm			8 mm		
Height x Length	43 x 58 mm			43 x 58 mm		
Stripping Length	9.5 mm			9.5 mm		
Insulation Material	Polyamide 6.6			Polyamide 6.6		
Type of Connection	2 screw clamps			2 screw clamps		
Fusion Voltage				24V AC/DC, 48V AC/DC, 110V AC/DC, 220V AC		
Type of Fuse Used	Ø5x20, Ø5x25 mm			Ø5x20, Ø5x25 mm		
Approvals						
Wire Range	22-12 AWG	0.5-4 sq.mm	22-10 AWG	22-12 AWG	0.5-4 sq.mm	22-10 AWG
Voltage Rating	600 V	750 V	600 V	600 V	750 V	600 V
Current Rating	6.3 A	6.3 A	6.3 A	6.3 A	6.3 A	6.3 A
Torque	7 lb-in	0.5 Nm	7 lb-in	7 lb-in	0.5 Nm	7 lb-in
	Cat. No.	Std. Pk.		Cat. No.	Std. Pk.	
Terminal Block	CSFL4U	100		CSFL4U(L)*	50	
End Plate 	EPCSFL4U	50		EPCSFL4U	50	
Isolation Partition 	PPCSFL4U	50		PPCSFL4U	50	
DIN Rail <i>for ordering information refer to page 57</i>						
End Stop <i>for ordering information refer to page 58</i> 	CA702	50		CA702	50	
	CA802	50		CA802	50	
External Jumper 	CA711/2	100		CA711/2	100	
	CA711/3	100		CA711/3	100	
	CA711/4	100		CA711/4	100	
	CA711/10	50		CA711/10	50	
Marking Tags (MT Type)  (MT Type on Lever)	MT8	100		MT8	100	
	MT2	100		MT2	100	
Continuous 90mm strip 	MT9F	10		MT9F	10	

CAFL4U		CAFL4U(L)*		CAFL4U(N)		CB1038		
								
9 mm		9 mm		9 mm		17.5 mm		
50 x 72 mm		50 x 70 mm		50 x 70 mm		77 x 63.5 mm		
12 mm		12 mm		12 mm		11 mm		
Polyamide 6.6		Polyamide 6.6		Polyamide 6.6		Aculon®		
2 screw clamps		2 screw clamps		2 screw clamps		2 screw clamps		
Ø1/4x1 in., Ø1/4x1 1/4 in.		Ø1/4x1 in., Ø1/4x1 1/4 in.		Ø1/4x1 in., Ø1/4x1 1/4 in.		Ø10 x 38 mm		
								
0.5-4 sq.mm 22-10 AWG		0.5-4sq.mm 22-10 AWG		0.5-4sq.mm 22-10 AWG		24-4 AWG 1.5-25sq.mm 24-4 AWG		
600 V 600 V		600 V 600 V		600 V 600 V		600 V 400 V** 600 V		
6.3 A 12 A		6.3A 12A		6.3A 12A		30A 32A** 30A		
0.5 Nm 7 lb-in		0.5 Nm 7 lb-in		0.5 Nm 7 lb-in		31 lb-in 2-2.5 Nm 31 lb-in		
Cat. No.	Std. Pk.	Cat. No.	Std. Pk.	Cat. No.	Std. Pk.	Cat. No.	Std. Pk.	
CAFL4U	25	CAFL4U(L)*	25	CAFL4U(N)	25	CB1038-1	1	
EPCAFL4U	50	EPCAFL4U	50	EPCAFL4U	50	<i>available up to 4 pole</i>		
								
CA702	50	CA702	50	CA702	50	CA702	50	
CA802	50	CA802	50	CA802	50	CA802	50	
CA716/2	100	CA716/2	100	CA716/2	100			
CA716/3	100	CA716/3	100	CA716/3	100			
CA716/4	100	CA716/4	100	CA716/4	100			
CA716/10	50	CA716/10	50	CA716/10	50			
MT9	100	MT9	100	MT9	100			
MT9F	10	MT9F	10	MT9F	10			

* Add required voltage to part number as a suffix. i.e. CAFL4U(L)/24 for 24V AC/DC.

** 25A @ 500 V
10A @ 690V
16A @ 500V for fast blow

	DDFL4U			DDFL4U(E)*			DDFL4U(E)LR*		
									
Terminal Width	8 mm			8 mm			8 mm		
Height x Length	66 x 88 mm			66 x 88 mm			66 x 88 mm		
Stripping Length	9.5 mm			9.5 mm			9.5 mm		
Insulation Material	Polyamide 6.6			Polyamide 6.6			Polyamide 6.6		
Type of Connection	4 screw clamps			4 screw clamps			4 screw clamps		
Fusion Voltage				24V AC/DC, 48V AC/DC, 110V AC/DC, 220V AC			24V AC/DC, 48V AC/DC, 110V AC/DC, 220V AC		
Type of Fuse Used	Ø5x20, Ø5x25 mm			Ø5x20, Ø5x25 mm			Ø5x20, Ø5x25 mm		
Approvals									
Wire Range	22-12 AWG	0.5-4 sq.mm	22-10 AWG	22-12 AWG	0.5-4 sq.mm	22-10 AWG	22-12 AWG	0.5-4 sq.mm	22-10 AWG
Voltage Rating	600 V	600 V	600 V	600 V	600 V	600 V	600 V	600 V	600 V
Current Rating	Top Level		Bottom Level	Top Level		Bottom Level	Top Level		Bottom Level
	6.3 A	6.3 A	6.3 A	6.3 A	6.3 A	6.3 A	6.3 A	6.3 A	6.3 A
	25 A	32 A	35 A	25 A	32 A	35 A	25 A	32 A	35 A
Torque	7 lb-in	0.5 Nm	7 lb-in	7 lb-in	0.5 Nm	7 lb-in	7 lb-in	0.5 Nm	7 lb-in
	Cat. No.		Std. Pk.	Cat. No.		Std. Pk.	Cat. No.		Std. Pk.
Terminal Block	DDFL4U		20	DDFL4U(E)*		20	DDFL4U(E)LR*		20
End Plate 	EPDDFL4U		25	EPDDFL4U		25	EPDDFL4U		25
DIN Rail <i>for ordering information refer to page 57</i>									
End Stop <i>for ordering information refer to page 58</i> 	CA702		50	CA702		50	CA702		50
	CA802		50	CA802		50	CA802		50
Internal Jumper 	2 pole	CA729/2	100	2 pole	CA729/2	100	2 pole	CA729/2	100
	3 pole	CA729/3	50	3 pole	CA729/3	50	3 pole	CA729/3	50
	4 pole	CA729/4	50	4 pole	CA729/4	50	4 pole	CA729/4	50
	10 pole	CA729/10	10	10 pole	CA729/10	10	10 pole	CA729/10	10
Insulated Internal Jumper 	2 pole	CA749/2	100	2 pole	CA749/2	100	2 pole	CA749/2	100
	3 pole	CA749/3	50	3 pole	CA749/3	50	3 pole	CA749/3	50
	4 pole	CA749/4	50	4 pole	CA749/4	50	4 pole	CA749/4	50
	10 pole	CA749/10	10	10 pole	CA749/10	10	10 pole	CA749/10	10
Current Bar 	2 pole	CA703/6	100	2 pole	CA703/6	100	2 pole	CA703/6	100
	3 pole	CA704/6	100	3 pole	CA704/6	100	3 pole	CA704/6	100
	4 pole	CA705/6	100	4 pole	CA705/6	100	4 pole	CA705/6	100
	10 pole	CA737/10	100	10 pole	CA737/10	100	10 pole	CA737/10	100
Shorting Sleeve & Screw 	CA707/S/Q/3		100	CA707/S/Q/3		100	CA707/S/Q/3		100
External Jumper 	2 pole	CA711/2	100	2 pole	CA711/2	100	2 pole	CA711/2	100
	3 pole	CA711/3	100	3 pole	CA711/3	100	3 pole	CA711/3	100
	4 pole	CA711/4	100	4 pole	CA711/4	100	4 pole	CA711/4	100
	10 pole	CA711/10	50	10 pole	CA711/10	50	10 pole	CA711/10	50
Marking Tags (MT Type) 	MT8		100	MT8		100	MT8		100
(MT Type on Lever)	MT2		100	MT2		100	MT2		100
Continuous 90mm strip 	MT9F		10	MT9F		10	MT9F		10

*Add required voltage to part number as a suffix. i.e. CSFL4U(L)/24 for 24V AC/DC.